

 TREASURE GARDEN

# **AKZ** 11'oc/10'sq **Cantilever**

## *Assembly and Operation Guide*

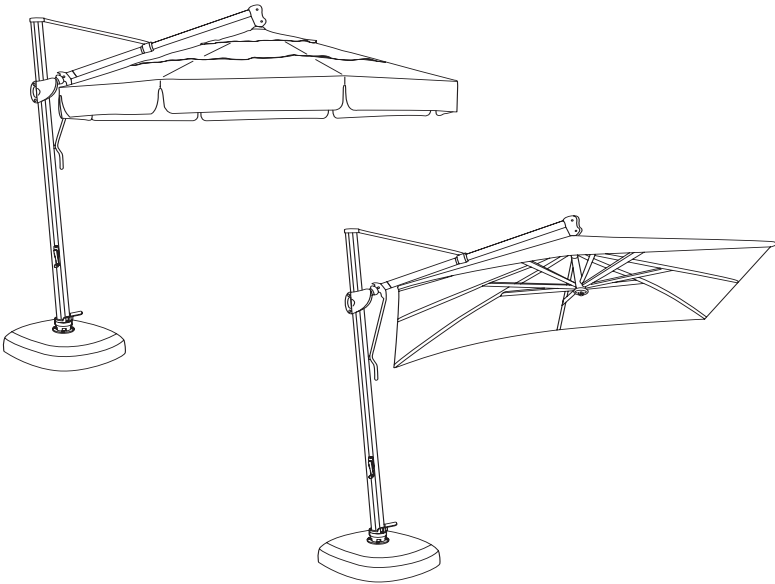

Thank you for your purchase of Treasure Garden's AKZ/AKZSQ Cantilever Umbrella.

Please remove all contents from the package, inspect and review checklist.



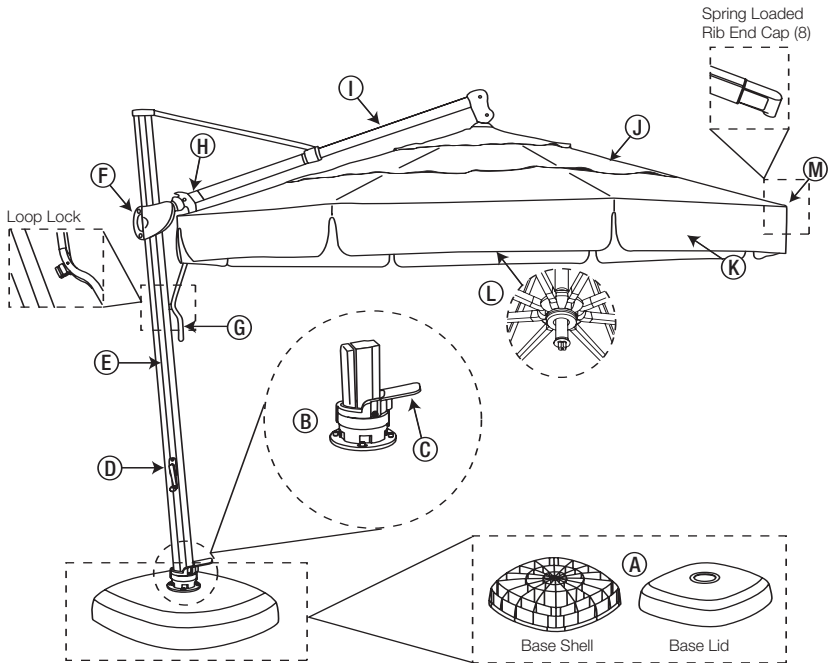









**CAUTION:** To reduce personal injury and damage to your AKZ/AKZSQ, read and follow this assembly and operation guide. We recommend a two-person team for assembly and disassembly. *Save information for future reference.*



## AKZ/AKZSQ CHECKLIST

- |                             |                                      |
|-----------------------------|--------------------------------------|
| A - Base Shell and Base Lid | H - Tilt Degree Scale                |
| B - 360° Rotating Hub       | I - Canopy Support Beam              |
| C - Base Pedal              | J - Canopy                           |
| D - Crank Lift Handle       | <b>AKZ:</b> Double Wind Vent (DWV)   |
| E - Main Frame Stand        | <b>AKZSQ:</b> Single Wind Vent (SWV) |
| F - Main Frame Grip         | K - Valance (Optional)               |
| G - Tilt Lever (Loop Lock)  | L - Vega™ Light Adapter              |
|                             | M - Spring Loaded Rib End Cap        |

## AKZ/AKZSQ PART LIST

Part		Description	Qty.
①		Base Shell	1
②		Base Lid	1
③		Steel Wrench	1
④		Inverted Base Stem	1
⑤		Mounting Plate	1
⑥		Playground Sand (not included)	200 lbs.
⑦		Large Hexagon Wrench	1
⑧		AKZ Main Frame	1
⑨		Crank Lift Handle	1
⑩		Small Hexagon Wrench	1
⑪		Hub Bolts	5
⑫		Plate Bolts	4
⑬		Washers	5

### REQUIRED FOR ASSEMBLY:

- 200 lbs. playground sand (not included).

**NOTE:** Do not put or allow sand into the center of the base shell.

**IMPORTANT:** Prior to assembly it is important to decide on the location of the AKZ umbrella. The umbrella measures approximately 10 ft. in height and 13 ft. in width.

- Allow ample height to avoid damage to your umbrella during assembly and usage.
- Choose a location that is level and sturdy.
- Avoid any sloping or soft ground cover.
- Consider a location that will maximize the umbrella's rotating swivel function. Placing the AKZ between two entertaining areas is ideal.

**NOTE:** Some parts may be included in the styrofoam packaging. DO NOT discard any packaging or box until assembly is complete.

## STEP 1 Base Assembly

Select area to set AKZ base and place in desired location. **NOTE:** Moving the umbrella will be difficult once fully assembled. Remove mounting plate from inverted base stem (Fig. 1). Remove the inverted base stem by using the steel wrench (provided) turning counter-clockwise  (Fig. 2), now remove base lid from base shell (Fig. 3). Return inverted base stem to base shell, to keep sand out of base stem channels. (Fig. 4)

**IMPORTANT:** Do not allow sand to spill inside the base stem channels, as it will impede further installation. Now, fill each section of the base shell with dry playground sand (Fig. 5). The AKZ base holds up to 250 lbs. of sand. When filling the base, it is necessary to wet down the sand after partial installation. Continue filling the base with remaining sand after wet down. **NOTE:** Base weight will be 300 lbs. after sand and water is added. Now, remove inverted base stem (Fig. 6) from base shell. Place base lid back onto base shell and re-install the inverted base stem (Fig. 7). **IMPORTANT: Carefully, as you tighten the inverted base stem, you will notice clicking/ratcheting sound. Please make sure it is between CLICKS. Do not over tighten inverted base stem or parts may be damaged.** Re-install the mounting plate by tightening with 4 plate bolts (Fig. 8 and 9).

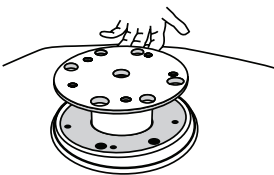

(Fig. 1)

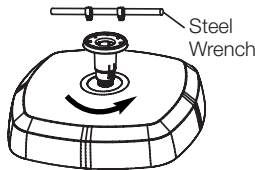

(Fig. 2)

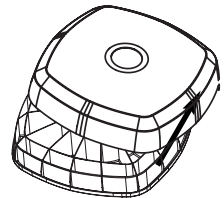

(Fig. 3)

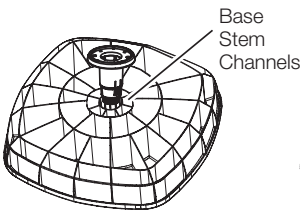

(Fig. 4)

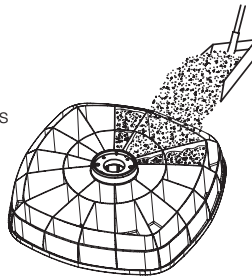

(Fig. 5)

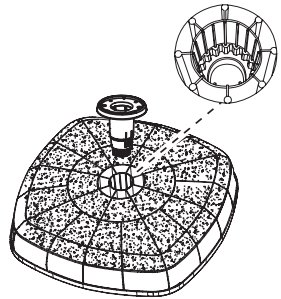

(Fig. 6)

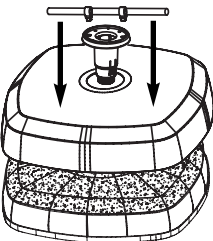

(Fig. 7)

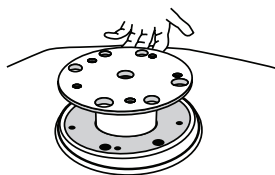

(Fig. 8)

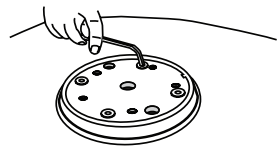

(Fig. 9)

## STEP 2 Umbrella Assembly

**NOTE: Two-persons recommended for team lift and the rest of the assembly.**

Remove rotating hub from the main frame by removing the (2) main frame bolts (Fig. 10), set aside bolts for later use. Now, place rotating hub into mounting plate (Fig. 11) and tighten with supplied (5) washers & (5) hub bolts (Fig. 12). Assemble main frame onto hub and lower carefully (Fig. 13). Insert the two bolts on bottom portion of main frame and tighten using large hexagon wrench provided (Fig. 13). **DO NOT OVER-TIGHTEN.** Locate the crank lift handle and install onto the mid-area of the main frame. Use the small hexagon wrench provided to lock in the small screw (Fig. 14).

**REMOVE ALL PLASTIC PACKAGING MATERIAL FROM ALL PARTS PRIOR TO OPENING UMBRELLA.**

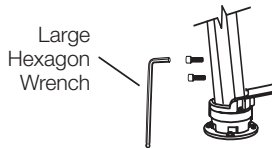

(Fig. 10)

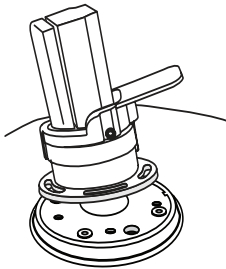

(Fig. 11)

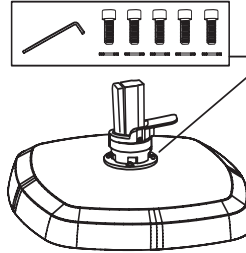

(Fig. 12)

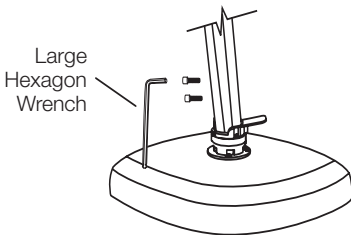

(Fig. 13)

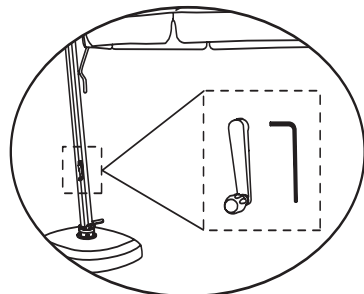

(Fig. 14)

### STEP 3 Operation

#### To OPEN Canopy:

Slowly turn the crank lift handle clockwise  (Fig. 15) to open the umbrella to a level position. **CAUTION:** Stop turning the crank handle as soon as the umbrella cover is completely open and the sleeve on the umbrella pole has reached its maximum height (Fig. 16). **NOTE:** Do not continue to crank once umbrella canopy is completely open, it may impair your ability to disengage the tilt lever.

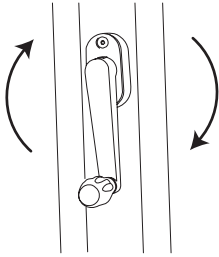

(Fig. 15)

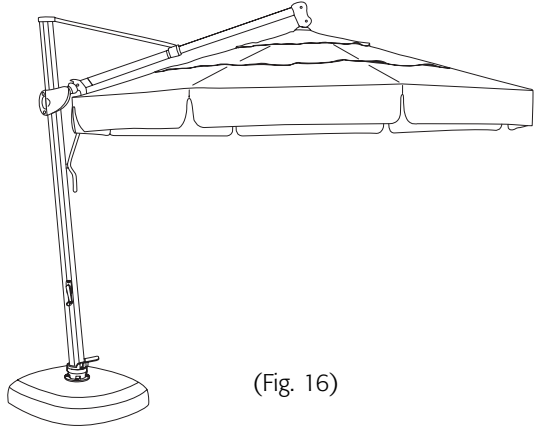

(Fig. 16)

#### To CLOSE Canopy:

Slowly turn the crank lift handle counter-clockwise  (Fig. 17) with one hand and slide the main frame grip down with the other hand (Fig. 18) until the canopy is fully closed (Fig. 19). **NOTE:** Prior to closing insure that the canopy is in a level (non-tilted) position.

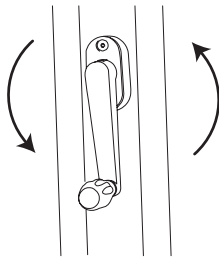

(Fig. 17)

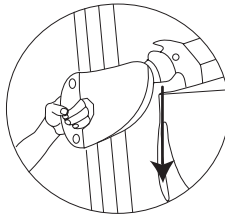

(Fig. 18)

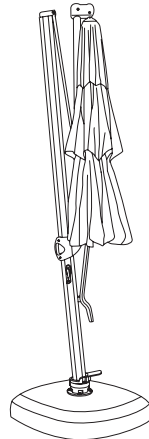

(Fig. 19)

**IMPORTANT:** To avoid personal injury or damage to the AKZ umbrella, it is important before you use the tilt feature to make sure the area around you is clear from any outdoor structure or furniture.

**To TILT Canopy:**

Make sure canopy is fully OPEN. Position yourself in front of the tilt lever and pull loop lock from main frame track (Fig. 20). Pull out further to dis-engage tilting gears and reveal gear teeth (Fig. 21). Move the tilt lever to the left or right, opposite to the desired tilt direction (Fig. 22). Use the tilt degree scale as a guide (Fig. 23). Now, push forward slightly to re-engage tilting gear teeth. Move tilt lever to center position (canopy should be moving also) and snap the loop lock back into main frame track.

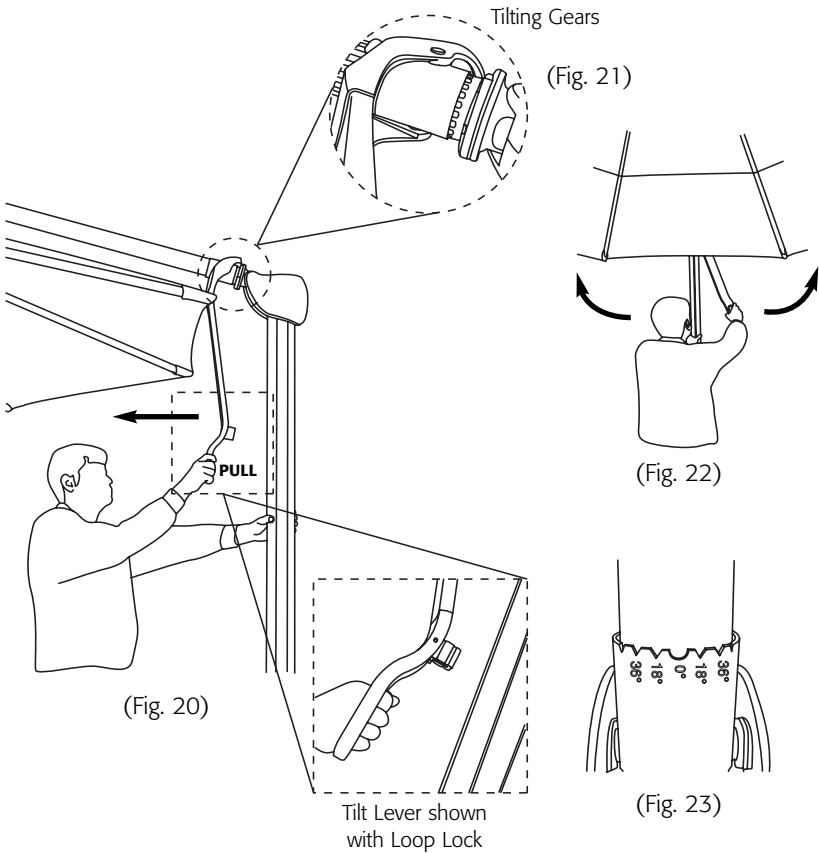

### To OPERATE the 360° Rotating Hub Swivel:

Place your foot on the base pedal of the rotating hub and push to release rotating lock (Fig. 24). Place one hand on the main frame and one hand on the tilt lever (Fig. 25), swivel the umbrella frame in either direction until desired position is reached (Fig. 26). Step off the base pedal to engage rotating lock and lock position (you will hear the pedal click, as it reaches the next available lock position).

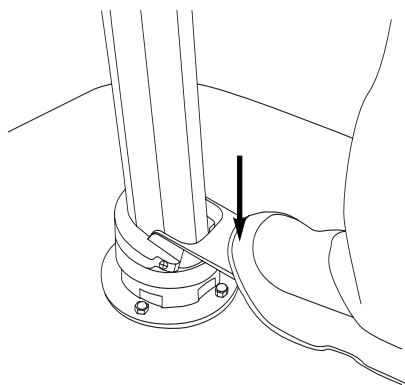

(Fig. 24)

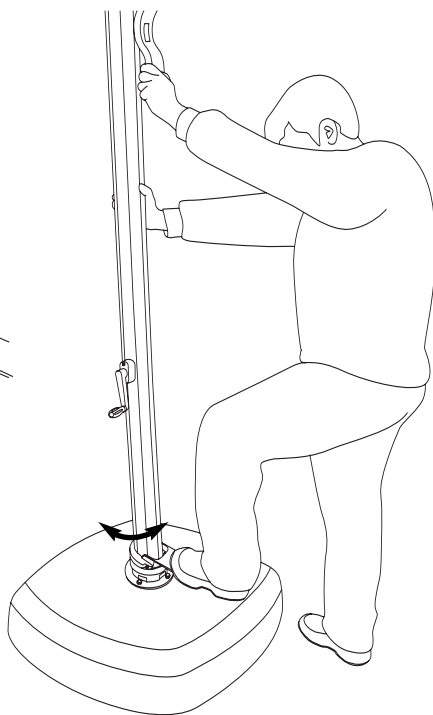

(Fig. 25)

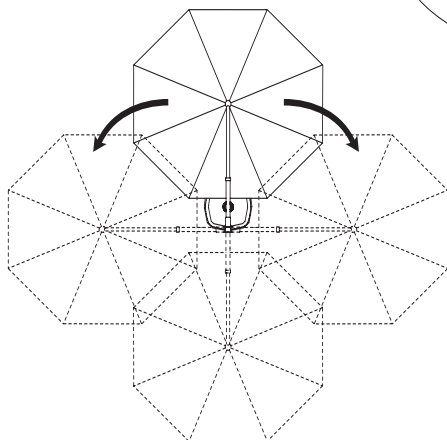

(Fig. 26)



### To ATTACH VEGA Umbrella Light:

Loosen the VEGA light adapter built into the umbrella runner by turning counter-clockwise  (Fig. 27). After loosening, pull down light adapter post (Fig. 28) to attach the VEGA umbrella light (sold separately).

### To OPEN and ATTACH VEGA:

Open the VEGA umbrella light by holding firmly with one hand and then depress the clamp release button with the other hand to release the clamp lock. Open up the VEGA light and clasp around the light adapter post (Fig. 29). Snap to close (Fig. 30).

### To REMOVE VEGA and CLOSE adapter:

Hold the VEGA umbrella light, depress the clamp release button to release the clamp lock. Remove VEGA umbrella light, and gently push up the light adapter post back into umbrella runner and tighten turning clockwise .

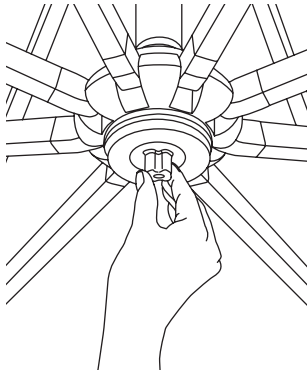

(Fig. 27)

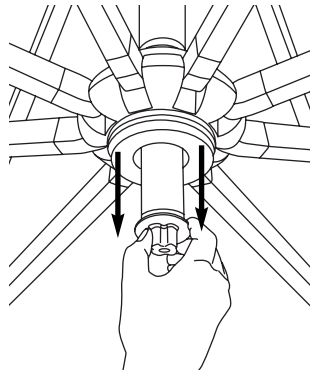

(Fig. 28)

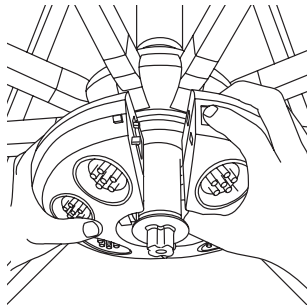

(Fig. 29)

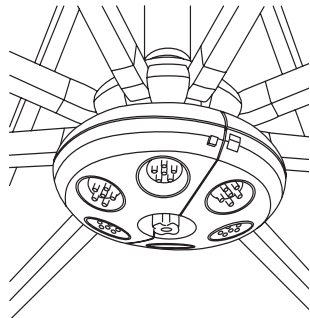

(Fig. 30)

## S A F E T Y   P R E C A U T I O N S :

- Close the umbrella in windy conditions or when a storm approaches.  
Never allow the umbrella to flap in the wind; this could damage the canopy.
- Do not leave open umbrella unattended. If damage occurs, this is not covered by the warranty.
- When adjusting the umbrella, make sure that no person(s) or item(s) are close to the umbrella. This is important to prevent injury or material damage.

## C A R E   A N D   M A I N T E N A N C E :

- When not in use, close and cover umbrella with a protective cover (included).
- Allow a wet canopy to dry opened up.
- If necessary, clean the fabric with lukewarm water, mild detergent, and a sponge.
- Wipe sliding marks on the aluminum poles with a damp cloth.

### Winter Storage:

- Store in a dry, protective place.
- Any visible defects must be repaired by a professional.

### After the Winter:

- Areas subject to turning and sliding can be treated with a non-staining lubricant spray (silicone-based).
- Check the condition and function of the umbrella. Any defects must be repaired by a professional.

**CAUTION:** Fully assembled, the AKZ/AKZSQ umbrella weighs over 300 lbs. Moving the umbrella fully assembled will increase the risk of damage to your umbrella and can cause serious injury. *We recommend a two-person team to assemble or disassemble the umbrella.*

## **WARRANTY:**

Treasure Garden warrants this product (in residential use) to be free from defects in original materials and workmanship for a period of 1 year from the date of purchase. If a defect in the original material or workmanship appears during the warranty period; Treasure Garden will (at its option) repair or replace the product without charge. Limited warranty of 4 years against fabric fading.

Simply contact your original authorized Treasure Garden dealer with a description of the defect. The dealer will verify the defect and work closely with Treasure Garden to obtain the necessary service. In many cases, simple problems can be solved with a replacement part that can be shipped directly to the dealer for professional installation/repair.

In the event that warranted factory service is required, Treasure Garden will assume the responsibility of the return freight charges on warranted product for the first year only.

Returned product that (upon receipt and inspection) is deemed to be "not covered" under our warranty, will be shipped/billed at your expense.

This warranty gives you specific legal rights, and you may have other rights which vary from state to state.

**NOTE:** Failure caused by unreasonable or abusive use, or failure caused by neglect of reasonable and necessary care are not covered by this warranty.

Additionally, acts of nature (including but not limited to wind, hurricanes, tornadoes, and storms) are not covered by this warranty.



[www.treasuregarden.com](http://www.treasuregarden.com)

©2010 Treasure Garden, Inc. - All Rights Reserved.

Initial 2/11